

# MBH 傳動座 (平底型)

圖示:MBH15-EP

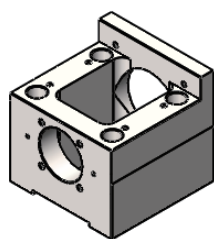

圖示:MBH15-D

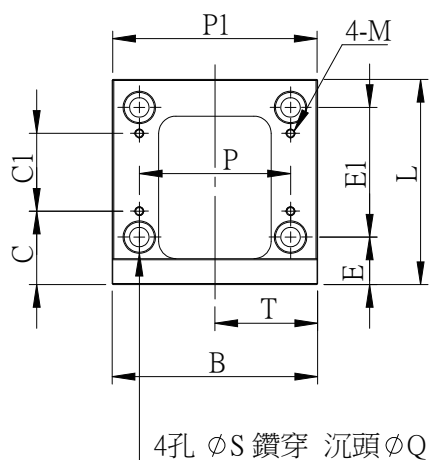
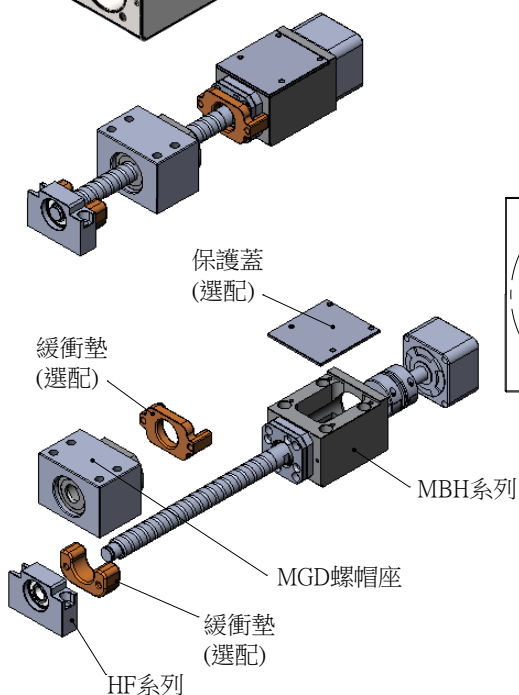
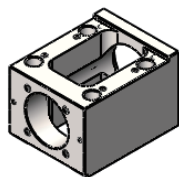

4孔  $\phi S$  鑽穿 沉頭  $\phi Q$

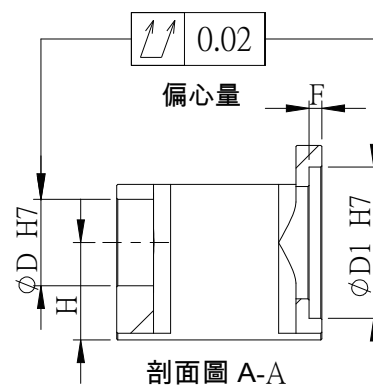
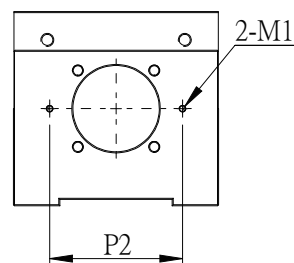
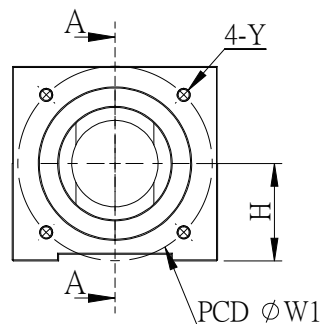

單位 : mm

型號	D1	W1	Y	L	D	H $\pm 0.02$	B	T	P	S	Q	E
MBH15-D	50	70	M5	88	40	30	70	35	54	6.6	11	23
MBH15-DP			M4									
MBH15-E	70	90	M6	95	40	45	95	47.5	70	9	14	22
MBH15-EP			M5									
MBH15H-EP			50									

型號	E1	P1	M	C	C1	M1	P2	F	重量 (Kgs)	支撐座		聯軸器
										固定端	支持端	
MBH15-D	50	-	M4	33	30	M3	61.5	5	1.14	FK 15	HF 15	SGS 34C SGS 40C
MBH15-DP									1.13			
MBH15-E	60	94.6	M4	34	36	M3	61.5	6	2.4	FK 15	HF 15H	SGS 45C SGS 50C
MBH15-EP									2.42			
MBH15H-EP									-			